

D

Optionen	Art.-Nr.
Handmeldergehäuse, rot ähnlich RAL 3020	704950
Handmeldergehäuse, blau ähnlich RAL 5015	704951
Ersatzglasscheibe (10 Stück)	704960
Beschriftungsfolie, transparent mit weißem Aufdruck, abweichend vom Standardpiktogramm (10 St.)	704961
Kunststoffbedienfeld (L) rücksetzbar, weiß (10 Stück)	704964
Abdeckung (O) zum Schutz vor unabsichtlicher Auslösung und Dichtungen zur Erhöhung der Schutzart von IP 43 auf IP 55	704965
Ersatzschlüssel (10 Stück)	704966
Montagerahmen für kleine Handfeuermelder inkl. Abdeckplatte rot + weiß (132 x 132 x 8 mm)	704967
Montagegehäuse, aP, rot ähnlich RAL 3020	704980
Montagegehäuse, aP, blau ähnlich RAL 5015	704981
Weiteres Zubehör siehe Produktgruppenkatalog	

GB

Options	Part No.
Housing for MCP, red similar to RAL 3020	704950
Housing for MCP, blue similar to RAL 5015	704951
Replacement glass screen (10 pieces)	704960
Label, transparent with whit printing, differing from standard icons (10 pieces)	704961
Plastic operating panel (L) resettable, white (10 pieces)	704964
Abdeckung (O) to protect the detector for unintended activation and washers to increase the protection rating from IP 43 up to IP 55	704965
Replacement key (10 pieces)	704966
Frame for small Manual Call Points incl. cover red + white (132 x 132 x 8 mm)	704967
Back box for surface mounting, red similar to RAL 3020	704980
Back box for surface mounting, blue similar to RAL 5015	704981
See product group catalogue for additional accessories	

Montage / Mounting



Abb. 1: Abmessungen in mm
Fig. 1: Dimensions in mm



Abb. 2: Gehäuse öffnen / Plombe
Fig. 2: Open the housing / seal

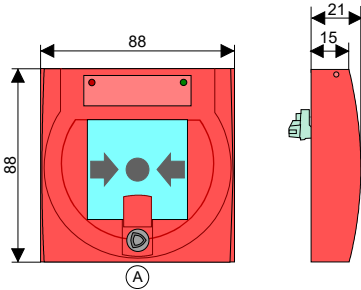

Abb. 3: Beschriftungsfeld
Fig. 3: Identification label

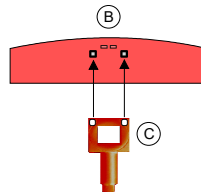

Abb. 4: Mechanische Alarmanzeige und LED, Glasscheibe, Papierinleger und Kunststoffbedienfeld
Fig. 4: Mechanical alarm indicator and LED, Glass screen, paper inlay and plastic operating panel

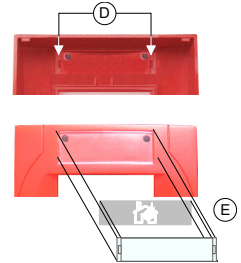

Abb. 5: Schlüsselstellung bei Test / Scheibe entnehmen
Fig. 5: Key lock position for test mode / removing screen

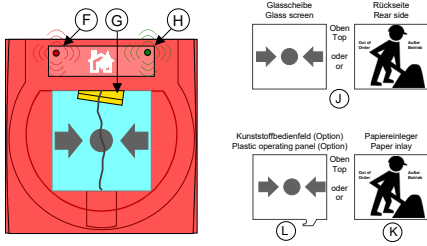

Abb. 6: Schlüsselstellung bei Rückstellung / Scheibe einsetzen
Fig. 6: Key lock position for Reset / Replace screen

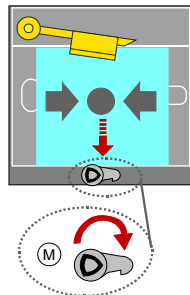

Abb. 7: Montagerahmen inkl. Abdeckplatte (Art.-Nr. 704967)
Fig. 7: Universal installation frame incl. cover (Part No. 704967)

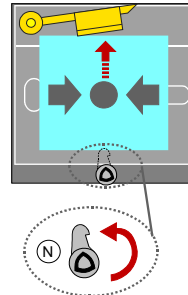

Abb. 8: Montagegehäuse, aP (Art.-Nr. 704980 / 704981)
Fig. 8: Back box for surface mounting (Part No. 704980 / 704981)

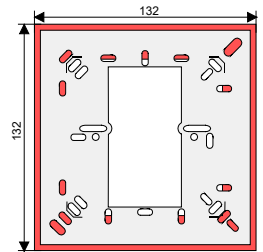

Abb. 9: Schutz-Kit (Art.-Nr. 704965) und Montagebeispiel der Kabelverschraubung 1-4
Fig. 9: Protection kit (Part No. 704965) and installation example for cable entries 1-4

- ① max. 4 Schrauben zur Wandmontage / max. 4 screws for wall mounting
- ② 2 Schrauben zur Befestigung des MCP auf Montagegehäuse / 2 screws to fix MCP onto mounting box

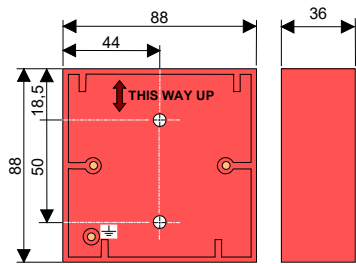
Anschaltung / Wiring

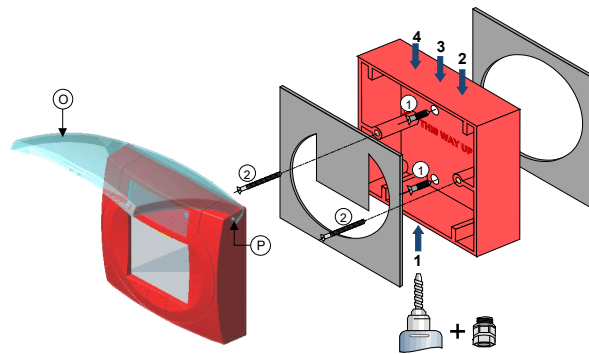
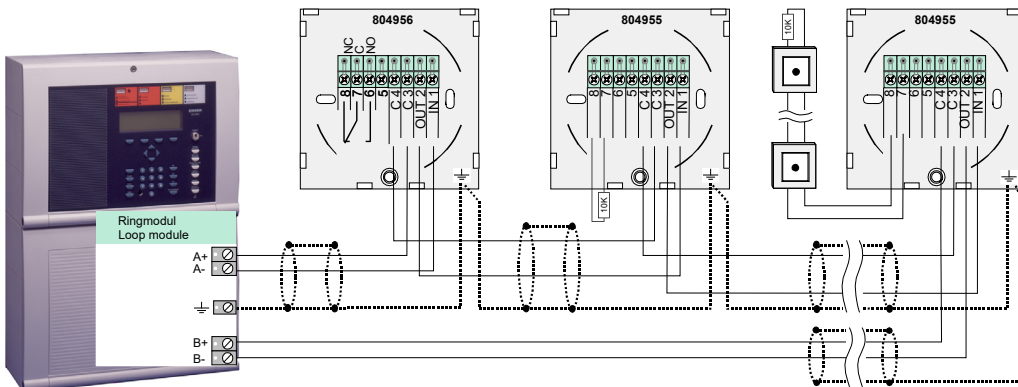

⚠ Drehmoment (max. 0,4 Nm) der Anschlussklemmen beachten!
Observe permitted torque (max. 0.4 Nm) of the terminals!

Abb. 10: Anschluss Ringleitung und Relais
Fig. 10: Wiring loop and relay